

ASSEMBLY INSTRUCTIONS

2RP3BLK, 2RP3CLR - Wall Mounted Acrylic Literature Display

Parts List

- A. Literature Rack
- B. Acrylic Divider
- C. Standoff
- D. Wall Anchor Set
- E. Header (sold separately)

Ax1

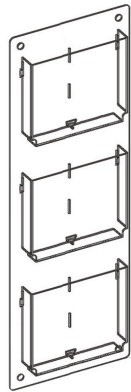

Bx3



Cx4



Dx4

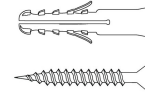

Ex1 (Optional, sold separately)

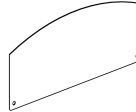

Scan QR code to visit the product page:



2 people are required

STEP 1. Hold the Literature Rack back panel (A) against the wall at the desired mounting location. Make sure the panel is level and mark the center of each hole at the corner.

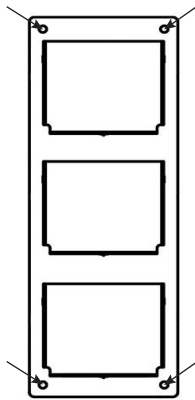

STEP 2. Set aside the rack and drill holes at the marked locations with a power drill. Insert the wall anchors into the holes and tap them flush with the wall surface.

Separate each standoff cap from its base. Securely fix each base using an anchor screw with a screw driver.

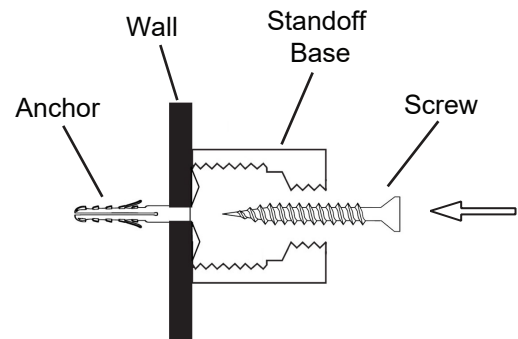

STEP 3. Peel off the protective film on each Divider (B). Slide 1 divider down and insert the tab into the slot on the back panel. Twist the divider and snap it into place.

Repeat this step to assemble all dividers that you plan to use.

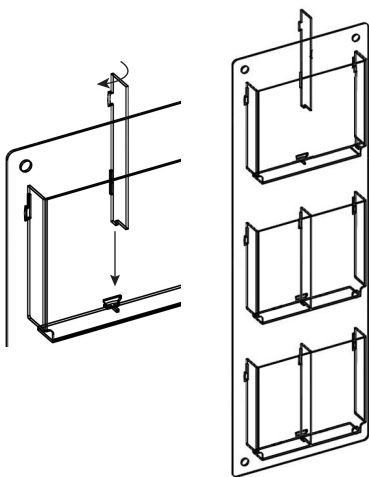

STEP 4. Carefully lift the assembled literature rack up and align the holes on the back panel with the mounted standoffs.

Hold the back panel and hand screw all 4 caps into the standoffs.

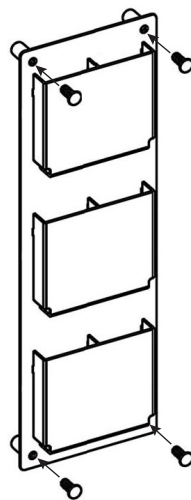

STEP 5 (Optional). To assemble the custom printed acrylic header (sold separately):

unscrew the top 2 standoff caps, and align the pre-drilled holes on the header with the corresponding holes on the panel, replace the caps to secure the header.

